

Data Sheet



Article number: 0105030

Description: Retaining ring AV 14

Note: Fitted with ZGA pliers

Measures

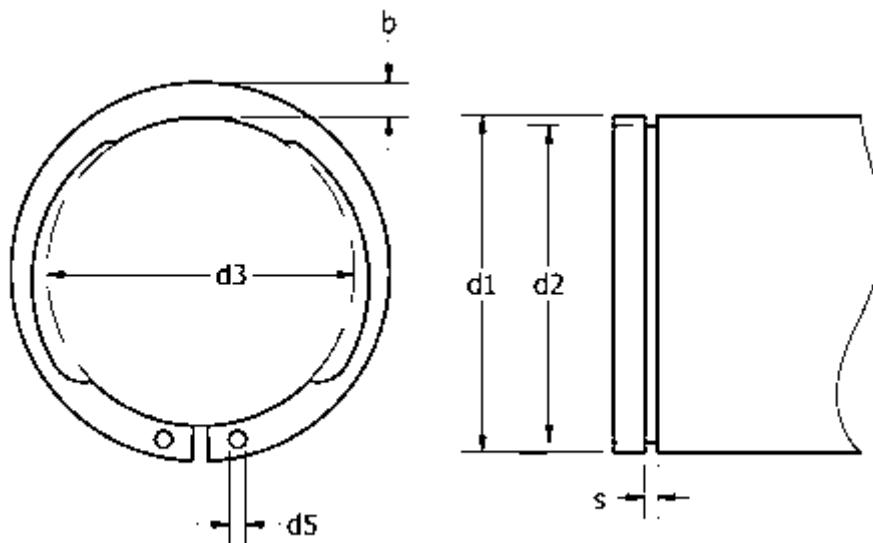

AN mm ²	= 5.8	FRg kN	= 2.4	t	= 0.30
b	= 2.1	FR kN	= 6.0	tol	= -0.06
d1	= 14	g	= 1.0	tol	= -0.11
d2	= 13.4	K kN-mm	= 19.2	tol	= +0,10-0,36
d3	= 12.90	m min	= 1.10	tol	= 0.1
d5 min	= 1.3	n abl x 1000	= 56	Tong	= ZGA-0
Description	= AV 14	s	= 1.00	Weight kg/1000	= 0.58
FN kN	= 0.97	Side power N at I2	= 0.9		